

Scanivalve

PNEUMATIC CONNECTOR, TUBING, & ACCESSORY CATALOG

Pneumatic Quick Connectors

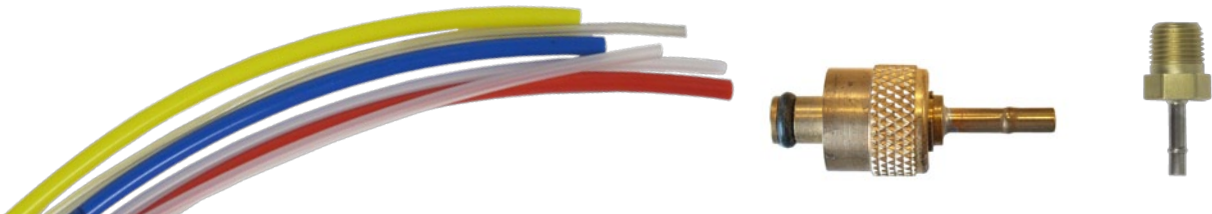

Plastic Tubing and Adaptors



Tube Connectors and Manifolds

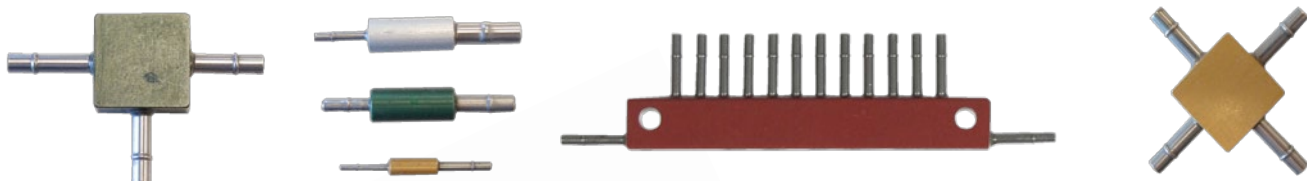

Plumbing Tools



Contents

| | |
|--|-----------|
| Plastic Tubing | 1 |
| Nylon Tubing | 1 |
| Vinyl Tubing (Clear) | 1 |
| Urethane Tubing (Clear) | 1 |
| Teflon Tubing (Clear) | 1 |
| Plastic Tubing Specifications | 2 |
| Tubing Clamps and Tools | 3 |
| Helical Tubing Clamps | 3 |
| NYCLMP Screw-Back Tool | 3 |
| Tubing Tools and Sealant | 4 |
| Plastic Tubing Push-on Tool | 4 |
| Plastic Tubing Cut-Off Tool | 4 |
| Pipe Sealant | 4 |
| Tubulations and Tubulation Tools | 5 |
| Bulged Stainless Steel Tubulations | 5 |
| Tubulation Bender | 5 |
| Tube/Pipe Connectors | 6 |
| Pipe Connectors | 6 |
| Tube Adaptors for X-Lok Compression Fittings (1500psi) | 6 |
| X-Lok Adaptors | 7 |
| X-Lok to Tubulation | 7 |
| Tube Inserts for X-Lok Compression Fittings | 7 |
| 5/16-24 SAE Adaptors | 8 |
| 5/16-24 to SV Adaptors | 8 |
| Pressure Taps and Patch | 9 |
| Pressure Tap | 9 |
| Pressure Patch | 9 |
| Pneumatic Connectors | 10 |
| Quick Disconnect (50-100psi) | 10 |
| 24C, 48C, and 64C | 11 |
| 24C Connector Dimensions (500psi) | 12 |
| 48C Connector Dimensions (500psi) | 12 |
| 64C Connector Dimensions (100psi*) | 12 |
| Model D (300psi) | 13 |
| ZOC (500psi) | 14 |
| MPS (100psi) | 15 |
| 70MPS (500psi) | 15 |
| Rectangular Connectors | 16 |
| RC2 (300psi) | 16 |
| RPC (75 - 1500psi) | 17 |
| Pneumatic Manifolds (500PSI) | 18 |
| Tube Connectors | 19 |
| Quick Couplers | 20 |
| Purge Adaptors | 21 |
| MPS Purge Adaptor | 21 |
| TCU Purge Adaptor | 21 |
| Pneumatic Calibration/Purge Valve | 22 |

Plastic Tubing

Scanivalve stocks clear plastic tubing for many applications including:

- Wind Tunnel Tests
- Flight Tests
- Gas Turbine and Diesel Tests
- R&D and Laboratory Use
- Industrial Test

Available stock materials are urethane, Nylon, vinyl and Teflon. Sizes are available to fit over .031 inch through .125 inch tubulations, but vary based on type. Tubing is always sold by the spool.

Nylon Tubing

This tubing is rated at 110°C* and is ideal for gas turbine testing. It fits snugly over our stainless steel tubulations and can be used without helical tubing clamps to 100 psi, or up to 1500 psi (burst pressure NYLN-063) with helical tubing clamps and sealant. As a special order, NYLN-125HW can be ordered in a variety of colors.

NYLN-063 is also available in a 19-tube, multi-tube bundle. Each strand of tubing in the bundled is label with a number every 12 inches.



Vinyl Tubing (Clear)

This tough, lightweight tubing carries a 65°C* rating. It fits snugly over our stainless steel tubulations, and can be used with or without our helical tubing clamps. It can be used for short duration tests up to 30 psi without helical clamps. Size .063 vinyl tubing has a recommended working pressure of 90 psi at 21°C.

Urethane Tubing (Clear)

Urethane tubing has a temperature rating of 95°C*. It is ideal for low pressure tests in wind tunnel models. The tubing is extremely flexible, resilient, and resistant to kinking. It fits snugly over our stainless steel tubulations and is resistant to weather, tearing, abrasion and impact. Size .063 urethane has a recommended working pressure of 100 psi at 21°C.

Teflon Tubing (Clear)

This chemically inert tubing is rated at 260°C*. It uses the same helical tubing clamps as the Nylon tubing. Size .063 Teflon tubing has a recommended working pressure of 500 psi at 21°C.

Tubing Material Sizes Typically Stocked

| For use on: | Vinyl | Nylon 6/6 (Clear) | Urethane | Teflon (PTFE) |
|-------------------------------------|--------------------------------|------------------------------|-----------------|-------------------------------|
| .031 Inch (0.79mm) O.D. tubulation | | | URTH-031 (I.D.) | |
| .040 Inch (1.02mm) O.D. tubulation | VINL-040 (I.D.) | NYLN-040 [†] (I.D.) | URTH-040 (I.D.) | TFLN-040 (I.D.) |
| .063 Inch (1.59mm) O.D. tubulation | VINL-063 (I.D.) | NYLN-063 (I.D.) | URTH-063 (I.D.) | TFLN-063 (I.D.) |
| .125 Inch (3.18 mm) O.D. tubulation | VINL-125 ^{**†} (I.D.) | NYLN-125HW (I.D.) | | TFLN-125 ^{**} (I.D.) |

* Temperature ratings are referenced to atmospheric pressure of 14.7 psia nominal.

** Do not use this tubing in vacuum applications

[†] Indicates special order

O.D.= Outside Diameter; I.D. = Inside Diameter

Plastic Tubing Specifications

| Part Number | I.D. Inches [mm]* | O.D. Inches [mm] | Recommended Working Pressure at 21°C PSI [kPa] | Burst Pressure at 21°C PSI [kPa] | Burst Pressure at 40°C PSI [kPa] | Max Operating Temperature °C [°F] | Min Operating Temperature °C [°F] | Burst Pressure at Max Operating Temperature PSI [kPa] | Minimum Bending Radius Inches[mm] | Spool Length Feet [Meters] | |
|------------------------------|-------------------|------------------|--|----------------------------------|----------------------------------|-----------------------------------|-----------------------------------|---|-----------------------------------|-----------------------------|-----------------------|
| NYLNL-063 | .057 [1.45] | .089 [2.26] | 1000 [6895] | 1500 [10340] | 1000 [6895] | 110 [225] | -65 [-85] | 800 [5515] | 1.25 [31.75] | 500 [152.4] 1000 [304.8] | |
| NYLNL-063 Multitube** | N/A | .49 [12.45] | See NYLNL-063 | | | | | | | | 450 ± 25 [137.2± 7.6] |
| NYLNL-125HW | .117 [2.97] | .187 [4.75] | 600 [4135] | 1000 [6895] | 750 [5170] | 100 [212] | -65 [-85] | 500 [3448] | 1.75 [44.45] | 250 [76.2] | |
| TFLNL-040 | .036 [0.91] | .068 [1.73] | 500 [3448] | 700 [4825] | 575 [3965] | 260 [500] | -70 [-94] | 70 [480] | 0.50 [12.7] | 500 [152.4] | |
| TFLNL-063 | .053 [1.35] | .086 [2.18] | 500 [3448] | 700 [4825] | 575 [3965] | 260 [500] | -70 [-94] | 70 [480] | 0.75 [19.05] | 1000 [304.8] | |
| TFLNL-125 | .106 [2.69] | .138 [3.51] | 200 [1380] | 350 [2415] | 240 [1655] | 175 [350] | -70 [-94] | 50 [345] | 1.25 [31.75] | 500 [152.4] | |
| URTH-031 | .027 [.69] | .051 [1.30] | 125 [860] | 375 [2585] | 160 [1100] | 95 [200] | -65 [-85] | 70 [480] | 0.188 [4.78] | 500 [152.4] | |
| URTH-040 | .034 [.86] | .066 [1.68] | 125 [860] | 350 [2415] | 150 [1035] | 95 [200] | -65 [-85] | 70 [480] | 0.25 [6.35] | 500 [152.4] | |
| URTH-063 | .054 [1.37] | .086 [2.18] | 100 [690] | 250 [1725] | 150 [1035] | 95 [200] | -65 [-85] | 50 [345] | 0.25 [6.35] | 500 [152.4] | |
| VINL-040 | .034 [.86] | .066 [1.68] | 100 [690] | 380 [2760] | 160 [1380] | 65 [150] | -40 [-40] | 45 [240] | 0.32 [8.12] | 500 [152.4] | |
| VINL-063 | .054 [1.37] | .086 [2.18] | 90 [620] | 240 [1725] | 125 [1100] | 65 [150] | -40 [-40] | 45 [240] | 0.50 [12.7] | 500 [152.4] | |
| VINL-125† | .106 [2.69] | .138 [3.51] | 40 [275] | 160 [1205] | 40 [345] | 65 [150] | -40 [-40] | 35 [240] | 0.63 [16.0] | 500 [152.4] | |

* All I.D. tolerances are ±0.002" with the exception of TFLNL tubing. All TFLNL is ±0.003".

** Specifications listed in this row apply to the full bundle. See NYLNL-063 for individual tubes.

† Special Order. Please consult factory.

Tubing Clamps and Tools

Helical Tubing Clamps

These tubing clamps are used to clamp plastic tubing onto the stainless steel tubulations which extend from our Scanivalve modules and line of connectors, reducers, and manifolds. The brass clamps are designed to fit over our vinyl and urethane tubing on the tubulation. The stainless steel clamps are designed to fit over our Nylon and Teflon tubing. Clamps, tools, and tubing sizes are based on Scanivalve nominal stainless steel tubulation outside diameter. Actual dimensions of clamps, tools, and tubing may vary.

To Order, Specify: Clamp Part Number

| Bulged Stainless Steel Tubulation Size | For use with Scanivalve Tubing type | Clamp Part Number | Material |
|--|---|-------------------|-----------------|
| 0.042 Inch [1.07mm] O.D. | Vinyl (VINL-040) Urethane (URTH-040) | CLMP-040 | Brass |
| | Teflon (TFLN-040) Nylon (NLYN-040) | NYCLMP-040 | Stainless Steel |
| 0.063 Inch [1.59mm] O.D. | Vinyl (VINL-063) Urethane (URTH-063) | CLMP-063 | Brass |
| | Teflon (TFLN-063) Nylon (NLYN-063) | NYCLMP-063 | Stainless Steel |
| 0.125 Inch [3.18mm] O.D. | Vinyl (VINL-125) | CLMP-125 | Brass |
| | Teflon (TFLN-125) | NYCLMP-125 | Stainless Steel |
| | Nylon Heavy Wall (NLYN-125HW) | NYCLMP-125HW | Stainless Steel |



NYCLMP Screw-Back Tool

The Nylon screw-back tool is designed to manually install the helical clamps over the bulge of the tubulation. The screw-back tool is slipped onto the tubing and used to push the NYCLMP towards the tubulation bulge until the bulge is engaged. By rotating the screw-back tool a few revolutions, it will screw the NYCLMP over the bulge. Continue turning the handle on the screw-back tool until the clamp is located 80% over the bulge (on the side of the bulge closest to the termination of the tubing).

The versatile long-handled version, NCSBTL3, is especially suited for installing the NYCLMPs in hard to reach areas. The short-handled version, NCSBTL2 is used on panels where space is available.

Clamps, tools, and tubing sizes are based on Scanivalve nominal stainless steel tubulation outside diameter. Actual dimensions of clamps, tools, and tubing may vary.

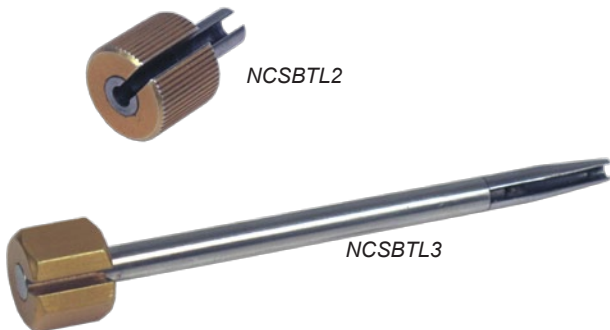
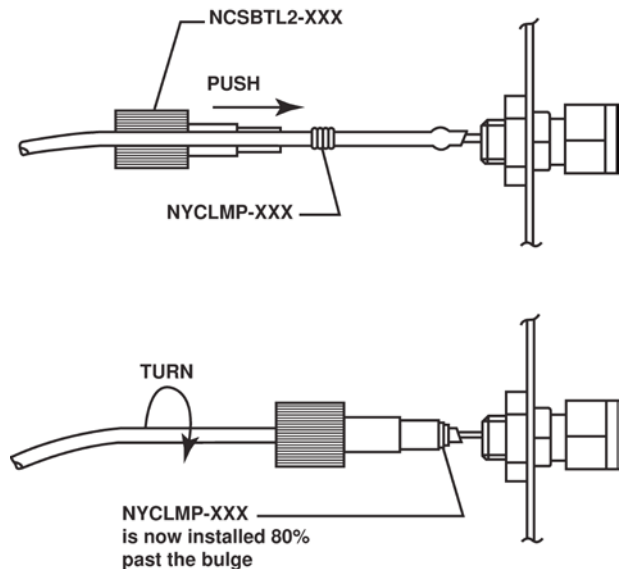

| To Order, Specify: | For Use With: |
|--------------------|---------------|
| NCSBTL2-063 | NYCLMP-063 |
| NCSBTL2-125 | NYCLMP-125 |
| NCSBTL2-125HW | NYCLMP-125HW |
| NCSBTL3-040 | NYCLMP-040 |
| NCSBTL3-063 | NYCLMP-063 |
| NCSBTL3-125 | NYCLMP-125 |
| NCSBTL3-125HW | NYCLMP-125HW |

Note: When Heavy Walled (HW) tubing is used, specify the HW Screw-back tool listed in the table.

Tubing Tools and Sealant

Plastic Tubing Push-on Tool

This tool is designed for use with vinyl, Nylon, Teflon and urethane tubing. The tool is used by grasping the tubing adjacent to the clamp (after the clamp has been screwed onto the tubing) and pushing it onto our standard stainless steel tubulations. It can also be used to push on tubing without clamps. Clamps, tools, and tubing sizes are based on Scanivalve nominal stainless steel tubulation outside diameter. Actual dimensions of clamps, tools, and tubing may vary.

| To Order, Specify: | For use with tubing size: | Approximate I.D. of tubing clamp Inches [mm] |
|--------------------|---------------------------|--|
| TPOTL-031 | -031 | .046 [1.17] |
| TPOTL-040 | -040 | .059 [1.50] |
| TPOTL-063 | -063 | .081 [2.06] |
| TPOTL-125 | -125 | .136 [3.45] |
| TPOTL-125HW | -125HW | .177 [4.50] |

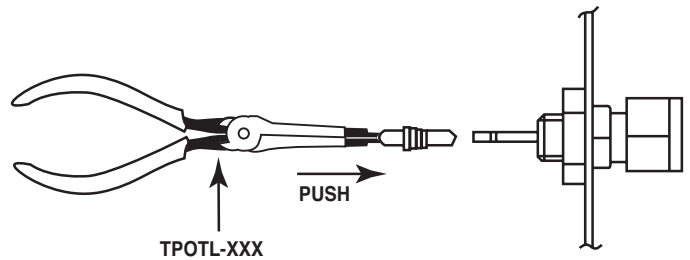

Plastic Tubing Cut-Off Tool

This tool is designed for use with vinyl, Nylon, Teflon and urethane tubing. The tool allows you to make a clean cut without distorting the plastic tubing. It works on any plastic tubing size from -031 to -125.

To Order, Specify: PTCTL



Pipe Sealant

The use of sealant with the helical tubing clamps is recommended for pressures above 250 psi. It is best used on Nylon and Teflon tubing. Each bottle is approximately 8 ml.

Application: Prior to tubing installation, lightly brush a small amount of sealant over the bulge of the stainless steel tubulation. Then drive the tubing and clamp onto the tubulation, using a small amount of twist to help spread the sealant. For high pressure applications, it is recommended that the SLNT2 is allowed to dry for 12-24 hours before full pressure is applied.

To Order, Specify SLNT2.



Tubulations and Tubulation Tools

Bulged Stainless Steel Tubulations

Scanivalve manufactures a complete line of bulged stainless steel tubulations. The tubing is bulged on one end to ensure leak tight connections. Scanivalve's plastic tubing and the brass or stainless steel helical tubing clamps fit over this bulge for a firm grip. It is recommended that the customer should epoxy the non-bulged end into their equipment. The tubulations are manufactured in lengths between 0.55 inches and 8.0 inches.



To Order, Specify: Scanivalve Part Number + Tubulation Length

| Scanivalve Part Number: | Standard Tubulation Lengths Inches | Tubulation Size* Inches [mm] |
|-------------------------|------------------------------------|------------------------------|
| TUBN-040 | .55, .75, 1.0, 2.0, 3.0, 4.0 | .042 Inch [1.07mm] O.D. |
| TUBN-063 | .56, .75, 1.0, 2.0, 3.0, 4.0 | .063 Inch [1.59mm] O.D. |
| TUBN-125 | .75, 1.0, 2.0, 3.0, 4.0 | .125 Inch [3.18mm] O.D. |

* Tubulation sizes are approximate. Please contact factory for exact measurements and tolerances.

Tubulation Bender

This tool is designed to bend 0.031", 0.042", and 0.063" OD stainless steel tubulations to angles anywhere up to 180°. Simply insert the tubulation into the hole and adjust the length slide block to set the length of the unbent tube. Adjust the angle position lock to the bend angle desired and then move the bending handle until it hits the angle stop.

Individual dies for different tubulation sizes (0.031", 0.042" and 0.063" OD tubulations) are included with each bender. Replacement dies can be purchased separately. For additional specifications, see the table below.



To Order, Specify: 5835-01

| Tubulation | Tubulation OD | Die Part Number | Approximate Bend Radius | Min. Tubulation Length | Min Tubulation Length for 90° |
|------------|-----------------|-----------------|-------------------------|-----------------------------------|-------------------------------|
| TUBN-031 | 0.031" [0.79mm] | 5838-1 | R.15 [3.302mm] | 0.75" [19.05mm] (60° max bend) | 1" [25.4mm] |
| TUBN-040 | 0.042" [1.07mm] | | | | |
| TUBN-063 | 0.063" [1.59mm] | 5838-2 | R.13 [3.81mm] | | |

Tube/Pipe Connectors

Pipe Connectors

These connectors are useful to connect small diameter plastic tubing with larger 1/8 inch and 1/4 inch NPT threaded pipe. Sizes are governed by the NPT standard.

Tubulation sizes available: .031 (non-bulged), .040, .063, or .125 inch OD.

To Order, Specify:

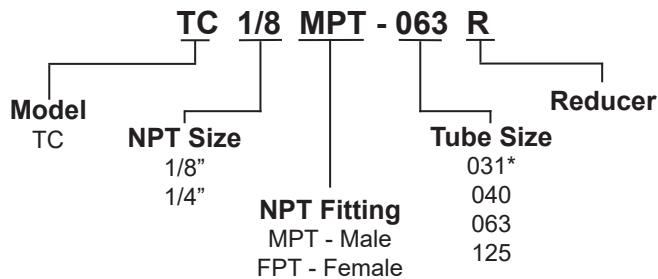

*.031 inch tubulations do not have a bulge
 † Tolerance ±0.03
 ‡ Tolerance ±0.05

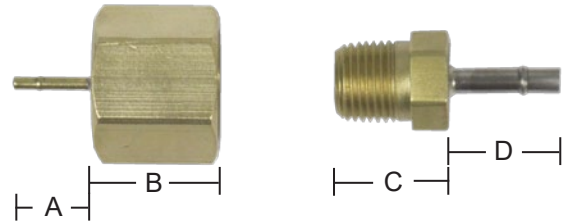

| NPT Size | Tubulation | A | B† | C‡ | D | Hex |
|----------|------------|-------|------|-------|-------|----------------------------|
| 1/8" | .031" | .360" | .56" | .52" | .360" | FPT - 9/16" MPT - 7/16" |
| | .042" | .360" | | | .410" | |
| | .063" | .400" | | | .400" | |
| | .125" | .500" | | | .540" | |
| 1/4" | .031" | .340" | .75" | .745" | .340" | FPT - 3/4" MPT - 9/16" |
| | .042" | .400" | | | .400" | |
| | .063" | .400" | | | .400" | |
| | .125" | .500" | | | .500" | |

Tube Adaptors for X-Lok Compression Fittings (1500psi)

Scanivalve has designed easy-to-use tube adaptors that fit X-Lok fittings. The main function of these tube adaptors is to reduce 1/8 or 1/4 inch compression fittings to our bulged tubulations.

These fittings can be hand tightened to form a leak tight O-ring seal. No tools are required. The tube adaptor material is brass or stainless steel with brass or stainless steel tubulations (dependent on configuration).

To Order, Specify: Scanivalve Part Number + Dash Number

| Scanivalve Part # | Dash Number | Tubulation Size | Compression Fitting Size | Stickout (A) | Length (B) |
|-------------------|-------------|-----------------|--------------------------|--------------|------------|
| 5365 | - 1 | Cap | 1/4" [6mm] | N/A | N/A |
| | - 12 | .042" | | .850" + A | |
| | - 2 | .063" | | | |
| | - 4 | .083" | | | |
| | - 3 | .125" | | | |
| 5375 | - 2 | Cap | 1/8" [3mm] | N/A | N/A |
| | - 4 | .042" | | .400" | .990" |
| | - 1 | .063" | | .360" | 1.0" |
| | - 5 | .125" | | .550" | 1.13" |

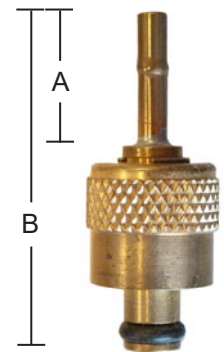

X-Lok Adaptors

X-Lok to Tubulation

These fittings provide a compression fitting to one end and a tubulation on the other. This fitting can be threaded or mounted to a wall to provide a pass through option when converting compression fittings to tubulations. The material can be stainless steel or brass. The nut included for the 1/8 pipe thread is brass.

To Order, Specify: Scanivalve Part Number + Dash number

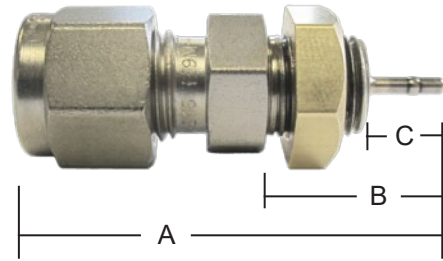

| Scanivalve Part # | Dash Number | Tubulation Size Inches [mm] | Material | Compression Fitting | NPT Size | A | B | C |
|-------------------|-------------|-----------------------------|-----------------|---------------------|----------|---------------|--------------|--------------|
| | | | | | | Inches [mm] | | |
| 57022 | - 1 | .063 [1.59] | Brass | 1/4" (6mm) | 1/8" | 1.660 [42.16] | .745 [18.92] | .370 [9.40] |
| | - 2 | .125 [3.18] | | | | 1.880 [47.75] | .965 [24.51] | .590 [14.99] |
| | - 3 | .063 [1.59] | Stainless Steel | | | 1.660 [42.16] | .745 [18.92] | .370 [9.40] |
| | - 4 | .125 [3.18] | | | | 1.880 [47.75] | .965 [24.51] | .590 [14.99] |
| 57032 | - 1 | .063 [1.59] | Brass | 1/8" (3mm) | 1/8" | 1.570 [39.88] | .745 [18.92] | .370 [9.40] |
| | - 2 | .125 [3.18] | | | | 1.770 [44.96] | .945 [24.00] | .570 [14.48] |
| | - 4 | .063 [1.59] | Stainless Steel | | | 1.600 [40.64] | .775 [19.69] | .400 [10.16] |
| | - 5 | .125 [3.18] | | | | 1.770 [44.96] | .945 [24.00] | .570 [14.48] |

Tube Inserts for X-Lok Compression Fittings

Scanivalve has designed easy-to-use tube adaptors that fit into X-Lok compression fittings. The main function of these tube adaptors is to utilize the compression fitting and adapt to Scanivalve tubulation sizes. These adaptors are all stainless steel.



To Order, Specify: Scanivalve Part Number + Dash Number

| Scanivalve Part # | Dash Number | Tubulation Size Inches [mm] | Material | Body O.D - 'D' Inches [mm] |
|-------------------|-------------|-----------------------------|-----------------|----------------------------|
| 57038 | - 1 | .063 [1.59] | Stainless Steel | .250 [6.35] |
| | - 2 | .125 [3.18] | | .250 [6.35] |
| | - 3 | .063 [1.59] | | .125 [3.18] |
| | - 7 | .040 [1.02] | | .125 [3.18] |

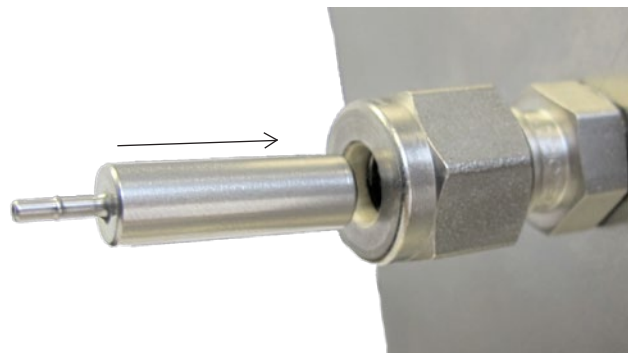

5/16-24 SAE Adaptors

5/16-24 to SV Adaptors

These connectors were designed to adapt a 5/16"-24 male thread matching the SAE J1926-1* standard to a common Scanivalve fitting type, such as a bulged tubulation, compression fitting, or 063 Quick Coupler. These fittings are used on the DSA5000 series pneumatic inputs, but can be used in other similar applications.

Fittings can be ordered in packs of 17, 22 or 36. Please contact the factory for different quantities.

Tubulation sizes available: 0.042", 0.063", or 0.125" OD
Compression sizes available: 1/16" or 1/8" OD
Quick Coupler sizes available: 0.063" OD

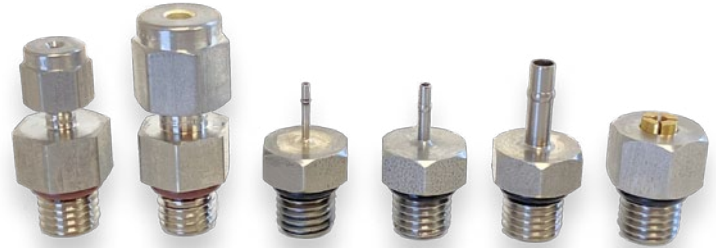

To Order, Specify: Part Number

| FITTING | OPTION | SIZE | MATERIAL | PART NUMBER (Pack of 17) | PART NUMBER (Pack of 22) | PART NUMBER (Pack of 36) |
|--|------------------------|-----------|-----------------------------------|-----------------------------|-----------------------------|-----------------------------|
| 5/16-24 Male Thread w/O-Ring (Buna-N) | Bulged Tubulation | 0.042" OD | Stainless Steel | 20009-09 | 20009-03 | 20009-06 |
| | | 0.063" OD | Stainless Steel | 20009-08 | 20009-02 | 20009-05 |
| | | 0.125" OD | Stainless Steel | 20009-07 | 20009-01 | 20009-04 |
| | Compression Fitting | 1/16" | Stainless Steel | 20008-09 | 20008-03 | 20008-06 |
| | | 1/8" | Stainless Steel | 20008-07 | 20008-01 | 20008-04 |
| | | | Brass | 20008-08 | 20008-02 | 20008-05 |
| | Other | QC-063 | Stainless Steel, Brass, Buna-N | 20010-03 | 20010-01 | 20010-02 |

* SAE J1926-1 is equivalent to ISO 11926-1 for 5/16"-24 o-ring sealing straight thread fittings.

All measurements = Inches [mm]

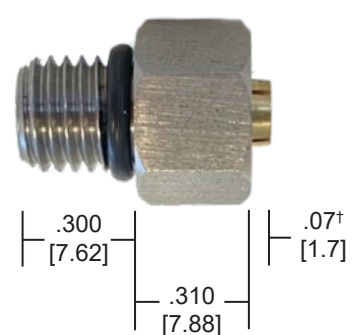
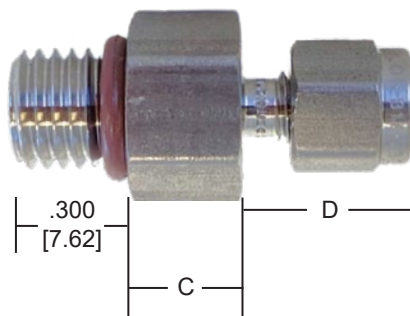
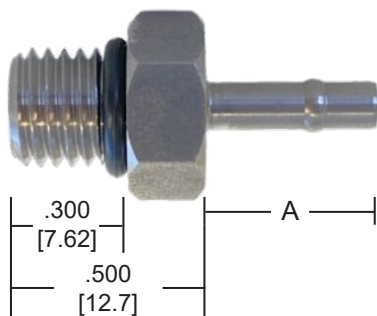

| Part No | Dash No | A | Hex |
|---------|---------|-----------------|-------|
| 20004 | -1 | .450 [11.43] | 7/16" |
| | -2 | .325 [8.25] | |
| | -3 | | |

| Part No | Dash No | C | D | Hex |
|---------|---------|----------------|----------------|-------|
| FTG | -526 | .275 [7.0] | .613 [15.6] | 7/16" |
| | -527 | | | |
| | -528 | .286 [7.26] | .43 [11.0] | |

| Part No | Dash No | Hex |
|---------|---------|-------|
| 5390 | -1 | 7/16" |

† Approximate

Pressure Taps and Patch

Pressure Tap

These pressure taps were designed to be a convenient solution for mounting tubulations to a model or test article. Using a hole drilled in the test article, the pressure tap can be fixed to the test article using adhesive. The through hole design of the tap (Dimension A) will allow for a flush finish on the exterior of the test article. Straight and 90 degree tubulation variants are available. The body of all taps are an aluminum 0.25" [6.35mm] hex.



Tubulation Sizes Available: .040" and .063"

To Order, Specify: Scanivalve Part Number + Dash Number

| Scanivalve Part Number | Tubulation Size | Orientation |
|------------------------|-----------------|-------------|
| 5855 | .040 | Straight |
| 5856 | .063 | Straight |
| 5865 | .040 | 90 Degree |
| 5866 | .063 | 90 Degree |

| Dash Number | | | | | | |
|-------------|----------------|----------------|----------------|----------------|----------------|----------------|
| | - 1 | - 2 | - 3 | - 4 | - 5 | - 6 |
| 'A' | .025 [.635] | .032 [.813] | .050 [1.27] | .063 [1.60] | .093 [2.36] | .125 [3.18] |

Please consider test article material thickness when choosing the 'A' dimension.

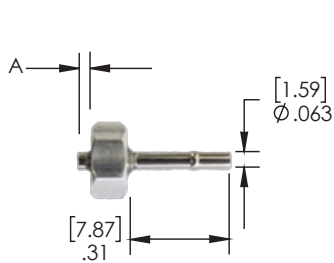

PN: 5856

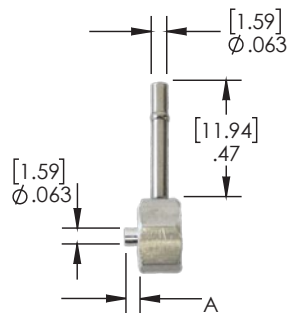

PN: 5866

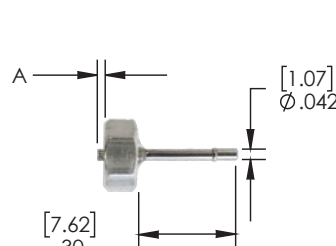

PN: 5855

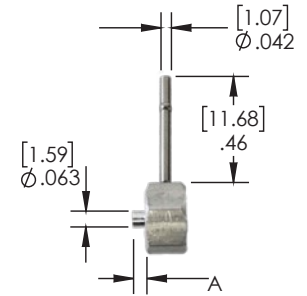

PN: 5865

Pressure Patch

The Pressure Patch is an alternate solution to the pressure tap in applications where drilling holes in the test article is unacceptable or inconvenient. A stainless steel tube is extruded from the chamber of an aluminum disk. The aluminum body can be fixed to the test article using an appropriate adhesive based on the application. The patch was designed and tested to have minimal aerodynamic influences when fixed to the flat surface of a test article.

Tubulation Sizes Available: .040" (non-bulged)

To Order, Specify: Pressure Patch (PN: 5857)

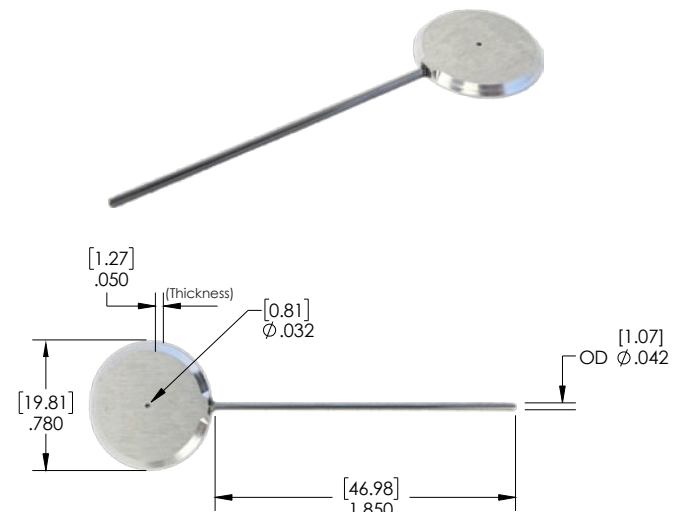

All measurements = Inches [mm]

Pneumatic Connectors

Quick Disconnect (50-100psi)

This family of connectors are ideal for making quick disconnects at test break points where space is important. These connectors have some of the highest channel density per connector that Scanivalve offers. A flat gasket is shipped with the male connector for providing an air tight seal. Blanking caps are available for some connector models as shown in the chart below.

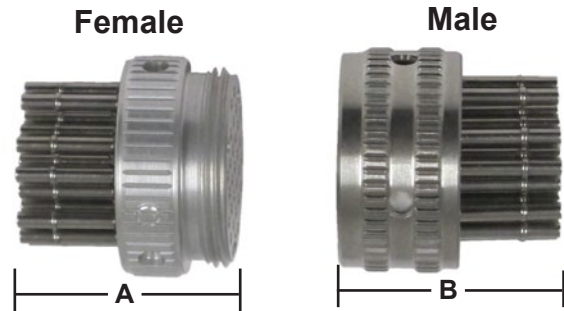

| Dimensions: Inches [mm] | | | | |
|-------------------------|--------------------|--------------|-------------|-----------------------|
| Number of Tubulations | Connector Diameter | A | B | Tubulation Dimensions |
| 7 | .345 [8.76] | .680 [17.3] | .615 [15.6] | .040 [1.02] O.D. |
| 14 | .390 [9.91] | .695 [17.65] | .680 [17.3] | .040 [1.02] O.D. |
| 19 | .460 [11.7] | .660 [16.8] | .690 [17.6] | .031 [.79] O.D.† |
| 19 | .460 [11.7] | .760 [19.3] | .790 [20.1] | .040 [1.02] O.D. |
| 31 | .560 [14.2] | .540 [13.7] | .650 [16.5] | .031 [.79] O.D.† |
| 31 | .560 [14.2] | .540 [13.7] | .580 [14.7] | .040 [1.02] O.D. |
| 31 | .900 [22.9] | .720 [18.3] | .765 [19.4] | .040 [1.02] O.D. |
| 31 | .900 [22.9] | .690 [17.6] | .765 [19.4] | .063 [1.59] O.D. |
| 36 | .625 [15.88] | .615 [15.6] | .655 [16.6] | .031 [.79] O.D.† |
| 36 | .625 [15.88] | .960 [24.4] | 1.0 [25.4] | .040 [1.02] O.D. |
| 55 | .700 [17.8] | .540 [13.7] | .565 [14.4] | .040 [1.02] O.D. |

A and B dimensions are the distance to the longest tube.

† All .031 tubulations are non-bulged

| To order, specify: Connector # + Tube Size | | | | Additional Accessories: | | | |
|--|------------------|----------------------|-----------|-------------------------|------------|--------------|------------------|
| Number of Tubulations | Male Connector # | Female Connector # | Tube Size | Spare Gasket # | Male Cap # | Female Cap # | Spanner Wrench # |
| 7 | 7M345‡ | 7F345‡ | 040 | 50968-1 | 50970-2 | N/A | 50190-10 |
| 14 | 14M390‡ | 14F390‡ | 040 | 50958-1 | N/A | N/A | 50190-11 |
| 19 | 19M460 | 19F460 | 031 | 50059-2 | 50013-3 | 50024-3 | 50190-09 |
| 19 | 19M460^^ | 19F460^^ | 040 | 50059-2 | 50013-3 | 50024-3 | |
| 31 | 31M560 | 31F560* | 031 | 50159-2 | 50013-2 | 50024-2 | 50190-06 |
| 31 | 31M560^ | 31F560^^ | 040 | 50159-2 | 50013-2 | 50024-2 | |
| 31 | 31M900 | 31F900* | 040 | 50139-2 | 50130-9 | 50131-2 | 1420-01A |
| 31 | 31M900 | 31F900* | 063 | 50139-2 | 50130-9 | 50131-2 | |
| 36 | 36M625 | 36F625* | 031 | 50778-1 | 50770-3 | 50776-3 | 50190-08 |
| 36 | 36M625^^ | 36F625^^ | 040 | 50778-1 | 50770-3 | 50776-3 | |
| 55 | 55M700 | 55F700* ^s | 040 | 50007-3 | 50013-1 | 50024-1 | 50190-01 |

^ Available in pyramid configuration. Specify at time of order.

^^ Only available in pyramid configuration.

‡ Max Pressure 50psi

* Available in Female Bulkhead

^s Available in Female Sealing Bulkhead

Note: Male Cap for Female Connector
Female Cap for Male Connector
Prices may vary based on configuration



Standard Configuration

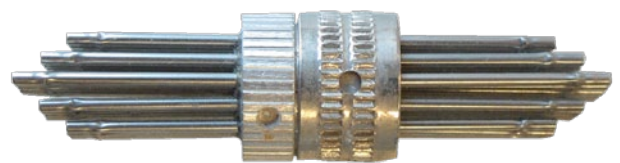

Pyramid Configuration

Pneumatic Connectors

24C, 48C, and 64C

The line of CM (male) connectors, when used with a CF (female connector), or a CFB (female bulkhead connector), become ideal quick disconnects at pressure break points. The stainless steel tubulations are designed to fit either Scanivalve 040, 063, or 125 tubing. A 2 inch retainer is available as an additional option.

Blanking caps, spare O-rings, gaskets, and gascages can be found in the table on the following page.



64CFB-1



64CF-1

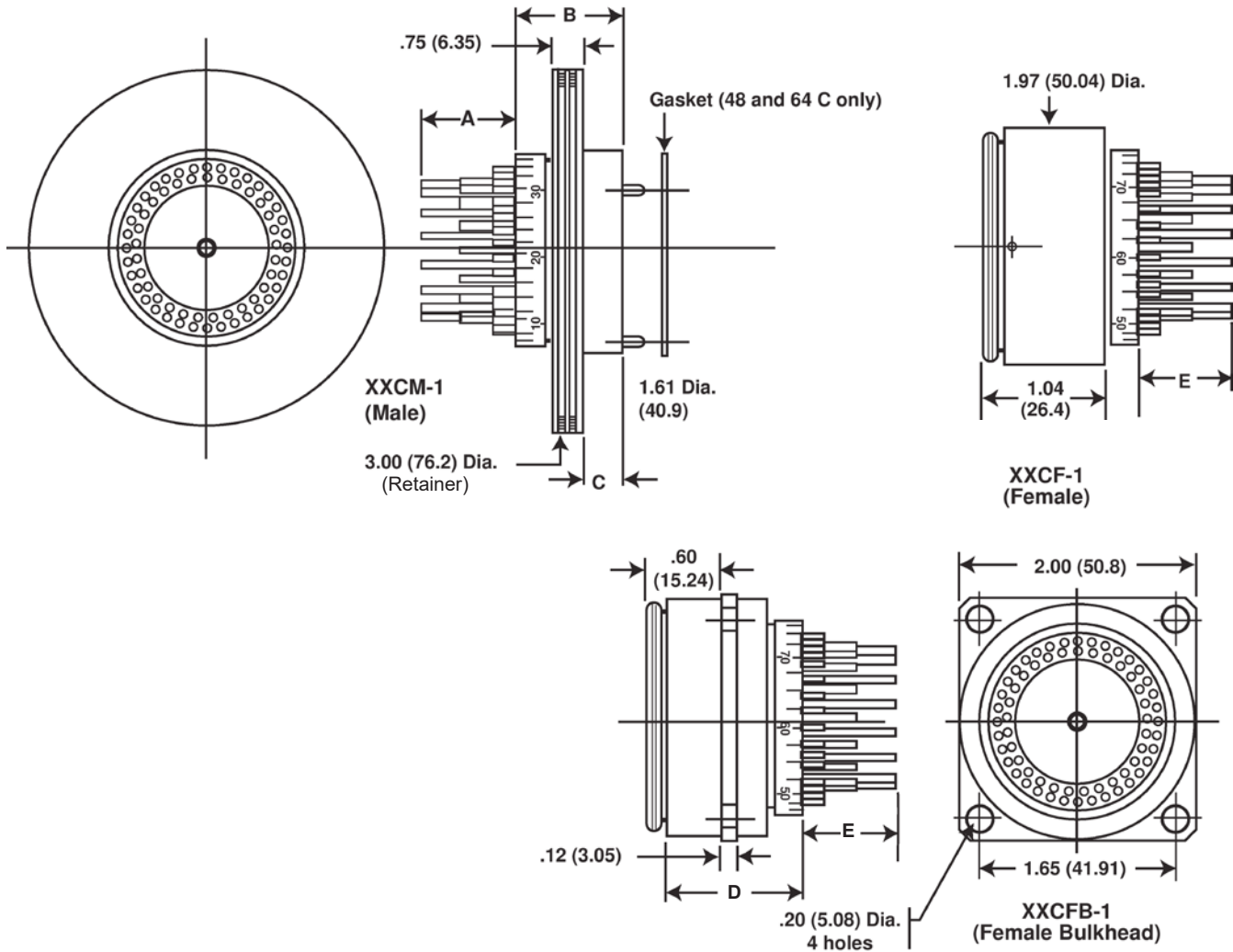

Pneumatic Connectors

24C Connector Dimensions (500psi)

| ScanCo# | Description | No. of Tubes | Tubulation Size | A | B | C | D | E | Cap |
|--------------------------------|---------------------------|--------------|-----------------|------------|------------|------------|-------------|------------|----------|
| 24CM-1 | Male Connector | 24 | .063 [1.59] | .61 [15.5] | .90 [22.9] | .36 [9.14] | | | 65020-14 |
| | | | .125 [3.18] | .86 [21.8] | | | | | |
| 24CF-1 | Female Connector | 24 | .063 [1.59] | | | | | .41 [10.4] | 65010-9 |
| | | | .125 [3.18] | | | | | .86 [21.8] | |
| 24CFB-1 | Female Bulkhead Connector | 24 | .063 [1.59] | | | | 1.30 [33.0] | .41 [10.4] | 65010-9 |
| | | | .125 [3.18] | | | | | .86 [21.8] | |
| 0995-070X-150B - Spare O-Rings | | | | | | | | | |

48C Connector Dimensions (500psi)

| ScanCo# | Description | No. of Tubes | Tubulation Size | A | B | C | D | E | Cap |
|---------|---------------------------|--------------|-----------------|------------|------------|------------|-------------|------------|--------|
| 48CM-1 | Male Connector | 48 | .040 [1.02] | .38 [9.7] | .82 [20.8] | .34 [8.64] | | | NA |
| | | | .063" [1.59] | .82 [20.8] | | | | | |
| 48CF-1 | Female Connector | 48 | .040 [1.02] | | | | | .42 [10.7] | 6386-1 |
| | | | .063" [1.59] | | | | | .83 [21.1] | |
| 48CFB-1 | Female Bulkhead Connector | 48 | .040 [1.02] | | | | 1.13 [28.7] | .42 [10.7] | 6386-1 |
| | | | .063" [1.59] | | | | | .83 [21.1] | |
| 6025 | Spare Gasket | | | | | | | | |
| 5180 | Optional Gascage | | | | | | | | |

64C Connector Dimensions (100psi*)

| ScanCo# | Description | No. of Tubes | Tubulation Size | A | B | C | D | E | Cap |
|---------|---------------------------|--------------|-----------------|------------|------------|------------|---|-------------|------------|
| 64CM-1 | Male Connector | 64 | .063 [1.59] | .77 [19.6] | .87 [22.1] | .34 [8.64] | | | NA |
| 64CF-1 | Female Connector | 64 | .063 [1.59] | | | | | .78 [19.8] | NA |
| 64CFB-1 | Female Bulkhead Connector | 64 | .063 [1.59] | | | | | 1.17 [29.2] | .78 [19.8] |
| 6305 | Spare Gasket | | | | | | | | |
| 6015 | Optional Gascage | | | | | | | | |

*Can be used up to 500psi with gascage. Please consult factory.
All measurements = Inches [mm]

Pneumatic Connectors

Model D (300psi)

The "D" Connectors make ideal quick disconnects at model test break points when both male and female connectors are used together. Both connectors are available with 24 or 48 stainless steel tubulations. Standard "D" connectors use a gasket and are limited to 100psi. For applications up to 300 psi, a gascage can be used and must be specified at the time of order. Male and female halves can be mated together to act as a reducer. Please consult the factory for this configuration.

Spare Gasket Part Number: 6088

Spare Gascage Part Number: 6058

Spare Spanner Wrench Part Number: 1040-01B

To Order, Specify:

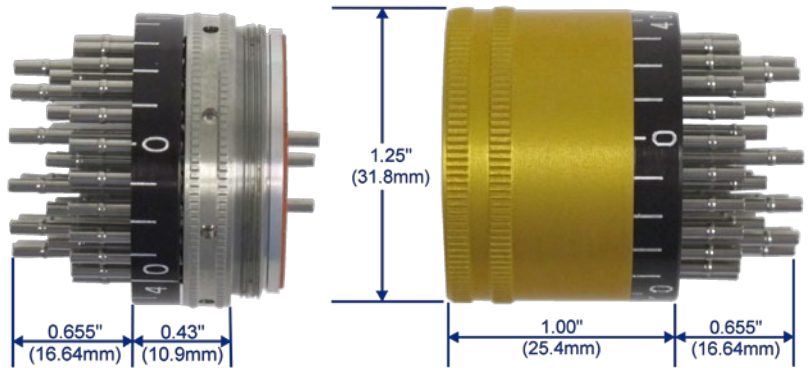
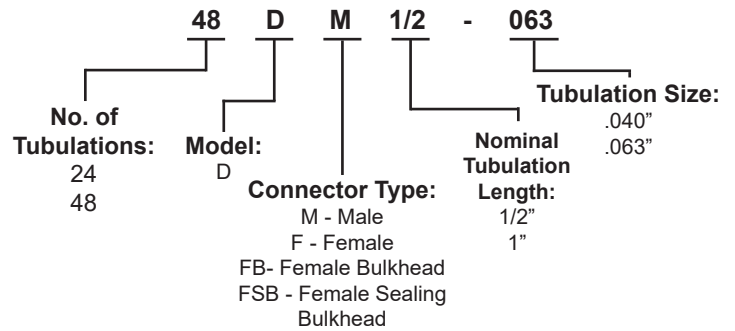

48DM-1/2
(Male)

48DF-1/2
(Female)

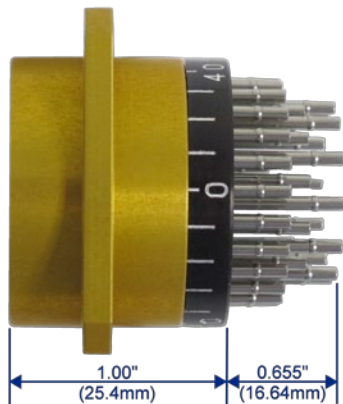

48DFB-1/2
(Female Bulkhead)

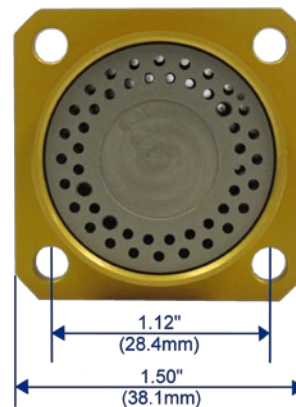

0.16" (4.06mm)
Diameter Holes
4 each

All measurements are approximate. Please see the 24D and 48D sales drawings on our website.

Pneumatic Connectors

ZOC (500psi)

This high density 48 or 73 channel connector is a very popular bulkhead quick disconnect. It contains either .063 inch O.D. tubulations or .040 inch O.D. tubulations. This pneumatic connector is also used on our ZOCTCU Thermal Control Units. It is capable for use up to 500 psi. Male and female halves can be mated together to act as a reducer. Please consult the factory for this configuration.

To Order, Specify:

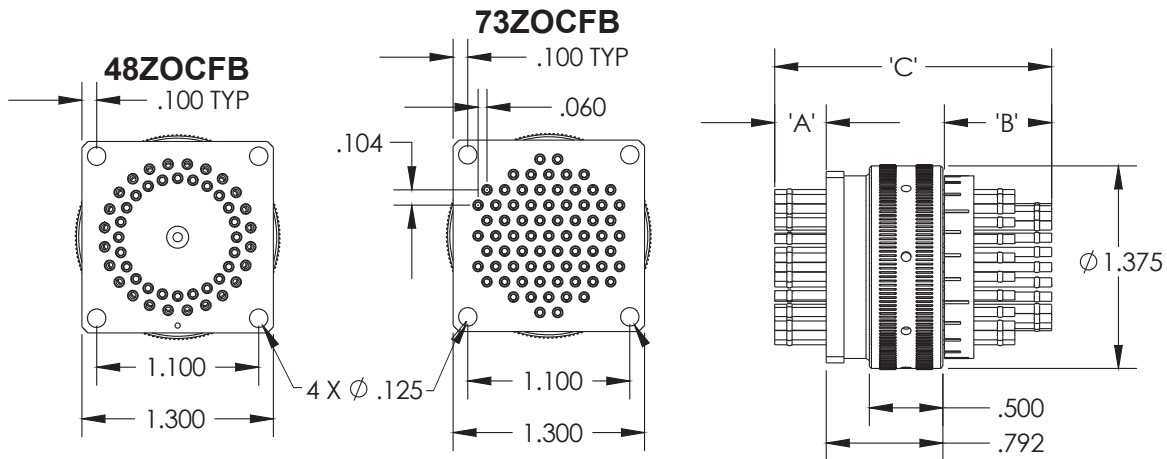
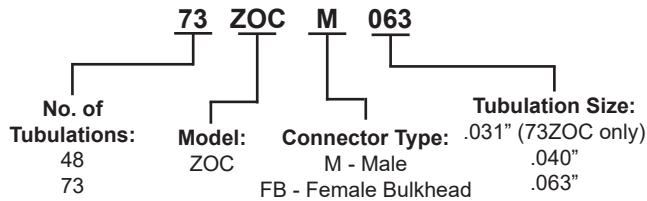

| ScanCo# | Description | No. of Tubes | Tubulation Size | A | B | C (M & F/FB) | Spare Gascage | Mating Cap |
|----------|---------------------------|--------------|-----------------|-------------|---------------|---------------|---------------|------------|
| 48ZOC-M | Male Connector | 48 | .040 [1.02] | | .990 [25.14] | 2.04 [51.82] | 5180-1 | 6541-4 |
| | | | .063 [1.59] | | 1.3 [33.02] | 2.44 [61.98] | | |
| 48ZOC-FB | Female Bulkhead Connector | 48 | .040 [1.02] | .260 [6.60] | | | 5180-1 | 6530-3 |
| | | | .063 [1.59] | .350 [8.89] | | | | |
| 73ZOC-M | Male Connector | 73 | .031 [.79]* | | .300 [7.62] | 1.350 [34.29] | 6557-1 | 6561-9 |
| | | | .040 [1.02] | | 1.050 [26.67] | 2.070 [52.58] | | |
| | | | .063 [1.59] | | 1.380 [35.05] | 2.500 [63.5] | | |
| 73ZOC-FB | Female Bulkhead Connector | 73 | .031 [.79]" | .260 [6.60] | | | 6557-1 | 6570-4 |
| | | | .040 [1.02] | .230 [5.84] | | | | |
| | | | .063 [1.59] | .330 [8.38] | | | | |

* .031 tubulations are non-bulged and non-staggered
 For spare Spanner Wrench, use part number 6535-01
 All measurements = Inches [mm]

Pneumatic Connectors

MPS (100psi)

The “MPS” Connectors make ideal quick disconnects at model test break points when both male and female connectors are used together. These connectors were based around the MPS4264 input header and contain the same ports. The connector consists of 16 or 32 ports of 0.031 (non bulged) or 0.040 tubulations, and one larger diameter port (always 0.063). The female connector has threaded holes and houses the O-Rings that seal the ports. Male and female halves with different tubulation sizes can be mated together to act as a reducer. The 16 and 32 connectors cannot be mated together.

Spare O-Rings for MPS Connector Part Number: 1443
Blanking cap for Male and Female connectors are available.

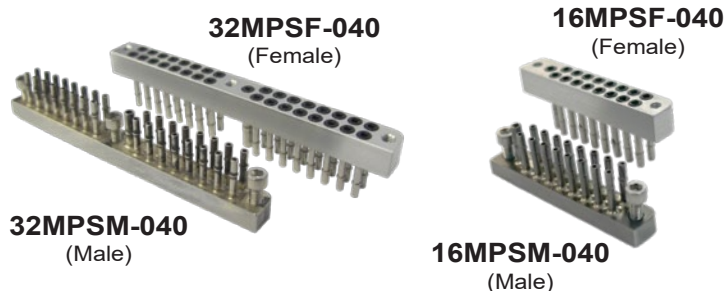

To Order, Specify:

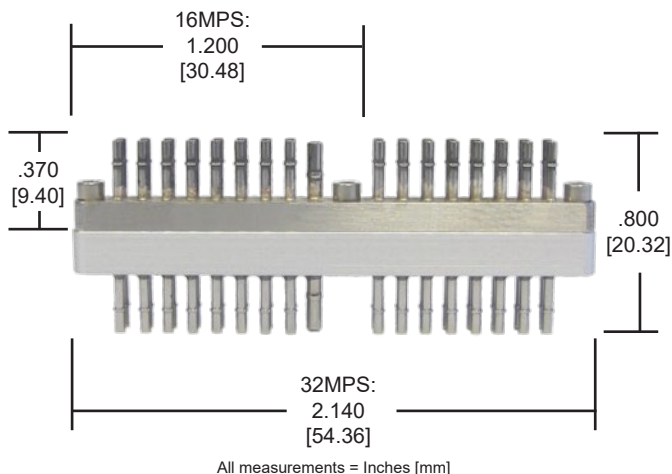
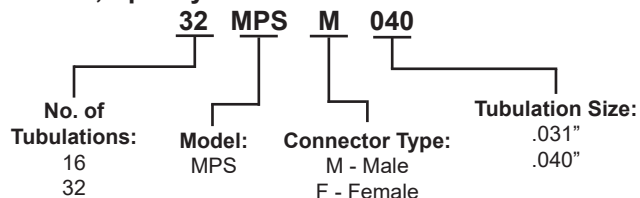

70MPS (500psi)

The “70MPS” Connectors make ideal quick disconnects at model test break points when both male and female connectors are used together. These pneumatic connectors are used on the MPSTCU and are rated for operating temperatures from -60°C to 125°C. The connector consists of 70 tubulation ports - 64 ports for “Px” connections in 0.031 (non-bulged, non-pyramid), 0.040, or 0.063 tubulations. The remaining 6 tubulations are always 0.063 tubulations - which were designed for the control inputs on the MPS. A gascage will be supplied with each male connector. Male and female halves with different tubulation sizes can be mated together to act as a reducer. Please consult the factory for this configuration.

Spare Gascage Part Number: 6557
Spare Spanner Wrench Part Number: 6535-01
Blanking cap for Male and Female connectors are available.

To Order, Specify:

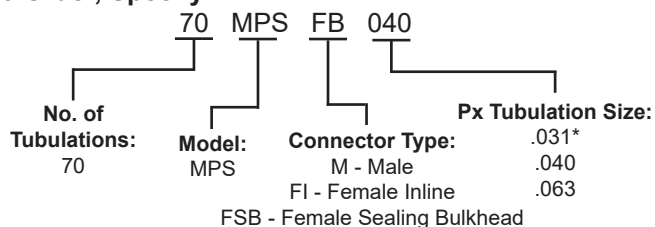

70MPSFI-040

70MPSM-040

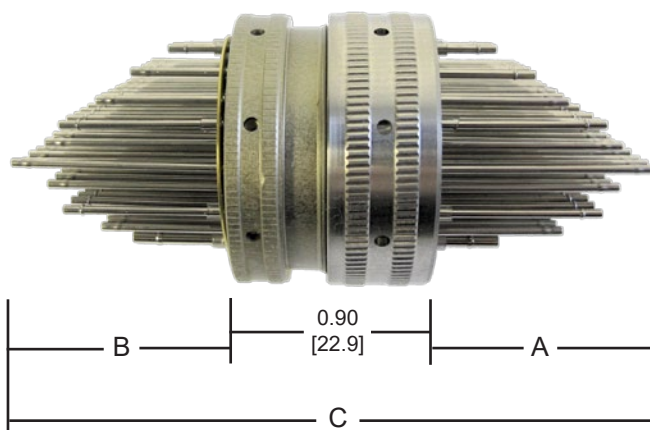

| | A | B | C | Diameter |
|------------------------------|--------------|--------------|--------------|--------------|
| 70MPS (0.063) | 1.380 [35.1] | 1.350 [34.3] | 3.62 [91.9] | 1.375 [34.9] |
| 70MPS (0.040) | 1.050 [26.7] | 1.060 [26.9] | 3.00 [76.2] | |
| 70MPS (0.031*) (non-pyramid) | 0.510 [13.0] | 0.390 [9.9] | 1.830 [46.5] | |

All measurements = Inches [mm]
* All 031 tubulations are non-bulged

Rectangular Connectors

RC2 (300psi)

The materials of construction for these connectors are stainless steel tubulations cemented into anodized aluminum blocks. These connectors utilize a gascage to retain the o-rings and provide a leak-tight seal when connected. When configured with .031, .040, or .063 tubulations, different halves can be mated together to act as a reducer (this does not apply to the .125 tubulations). Please consult factory for this configuration.

Available Colors: CLR (clear), GLD (gold), BLK (black), RED, GRN (green) and BLU (blue). If color is not specified at the time of order, Scanivalve will supply a color based on availability.

Tubulation Sizes Available: .031 (non-bulged), .040, .063 and .125 inches O.D.

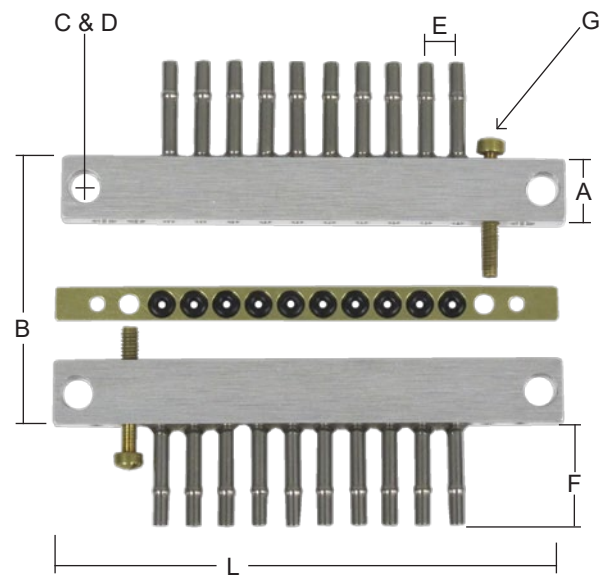

| Number of Tubes | Connector Length "L" in Inches [mm] | |
|-----------------|-------------------------------------|--------------|
| | For Tube Diameters: | |
| | .031, .040, .063 | .125 |
| 8 | 1.700 [43.2] | 2.875 [73.0] |
| 10 | 1.950 [49.5] | 3.375 [85.7] |
| 12 | 2.200 [55.9] | 3.875 [98.4] |

| Dimensions in Inches [mm] | | | | | | | | |
|---------------------------|-------------|-------------|---------------|-------------------|----------------------|-------------|-------------|--------------|
| Tube Diameter | Thickness | A | B (Assembled) | C (Hole Diameter) | D | E | F | G (Part No.) |
| .031 | .125 [3.18] | .250 [6.35] | .532 [13.51] | .125 [3.18] | No. 4 Mounting Screw | .125 [3.18] | .325 [8.26] | 20300-02 |
| .040 | | | | | | | .375 [9.53] | |
| .063 | | | | | | | .385 [9.78] | |
| .125 | .250 [6.35] | .375 [9.53] | .782 [19.86] | .140 [3.56] | No. 6 Mounting Screw | .250 [6.35] | .47 [11.94] | 20300-06 |

Each half of the connector can have different tubulation size, but body size will remain unchanged.

To Order, specify: Two (2) each RC2 connectors plus a gascage are required to make one connector assembly.

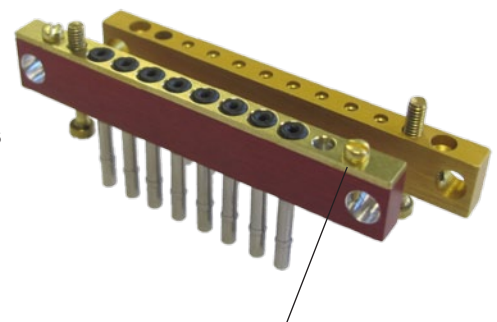
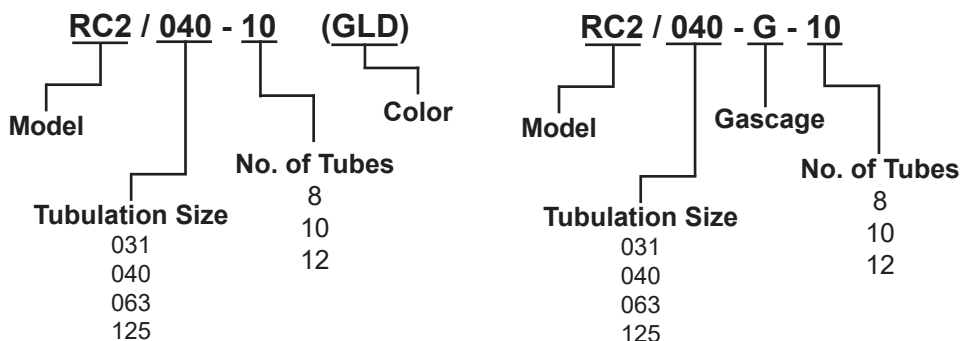

Screws supplied with gascage to fasten gascage to one half of the connector.

Rectangular Connectors

RPC (75 - 1500psi)

This Rectangular Pattern Connector (RPC) is ideal for making a quick disconnect at test break points. It is panel mounted and contains stainless steel tubulations. The sectioned side view of the drawing shows the front half of the connector which is not threaded. All of the holes are threaded in the threaded half (TH). Each side of the connector can have different tubulation sizes. O-rings are incorporated on the threaded half (TH) connector.

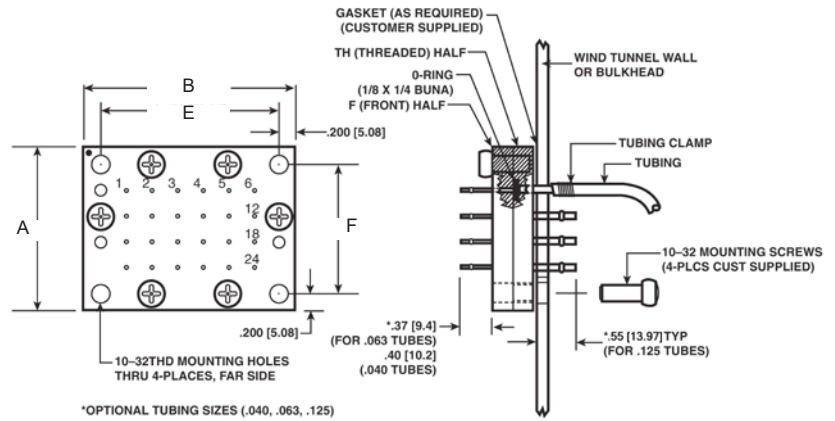

| No. of Rows | No. of Columns | No. of Tubes | Max Working Pressure (20°C) | A | B | E | F |
|-------------|----------------|--------------|-----------------------------|--------------|--------------|-------------|-------------|
| 2 | 4 | 8 | 1500PSI | 1.3 [33.02] | 1.9 [48.26] | 1.5 [38.1] | 0.9 [22.86] |
| 2 | 5 | 10 | | 1.3 [33.02] | 2.2 [55.88] | 1.8 [45.72] | 0.9 [22.86] |
| 3 | 4 | 12 | | 1.6 [40.64] | 1.9 [48.26] | 1.5 [38.1] | 1.2 [30.48] |
| 3 | 6 | 18 | | 1.6 [40.64] | 2.5 [63.5] | 2.1 [53.34] | 1.2 [30.48] |
| 4 | 4 | 16 | | 1.9 [48.26] | 1.9 [48.26] | 1.5 [38.1] | 1.5 [38.1] |
| 4 | 5 | 20 | | 1.9 [48.26] | 2.2 [55.88] | 1.8 [45.72] | 1.5 [38.1] |
| 4 | 6 | 24 | | 1.9 [48.26] | 2.5 [63.5] | 2.1 [53.34] | 1.5 [38.1] |
| 4 | 8 | 32 | | 1.9 [48.26] | 3.1 [78.74] | 2.7 [68.58] | 1.5 [38.1] |
| 4 | 10 | 40 | 850PSI | 1.9 [48.26] | 3.7 [93.98] | 3.3 [83.82] | 1.5 [38.1] |
| 5 | 10 | 50 | 550PSI | 2.2 [55.88] | 3.7 [93.98] | 3.3 [83.82] | 1.8 [45.72] |
| 6 | 6 | 36 | 850PSI | 2.5 [63.5] | 2.5 [63.5] | 2.1 [53.34] | 2.1 [53.34] |
| 6 | 8 | 48 | 550PSI | 2.5 [63.5] | 3.1 [78.74] | 2.7 [68.58] | 2.1 [53.34] |
| 6 | 9 | 54 | 450PSI | 2.5 [63.5] | 3.4 [86.36] | 3.0 [76.20] | 2.1 [53.34] |
| 6 | 10 | 60 | 375PSI | 2.5 [63.5] | 3.7 [93.98] | 3.3 [83.82] | 2.1 [53.34] |
| 8 | 8 | 64 | 375PSI | 3.1 [78.74] | 3.1 [78.74] | 2.7 [68.58] | 2.7 [68.58] |
| 8 | 12 | 96 | 200PSI | 3.1 [78.74] | 4.3 [109.22] | 3.9 [99.06] | 2.7 [68.58] |
| 10 | 10 | 100 | 150PSI | 3.7 [93.98] | 3.7 [93.98] | 3.3 [83.82] | 3.3 [83.82] |
| 10 | 12 | 120 | 100PSI | 3.7 [93.98] | 4.3 [109.22] | 3.9 [99.06] | 3.3 [83.82] |
| 12 | 12 | 144 | 75PSI | 4.3 [109.22] | 4.3 [109.22] | 3.9 [99.06] | 3.9 [99.06] |

Dimensions in Inches [mm]

See 80282 RPC Sales Drawing for additional information and recommended panel cut out sizes.

To order, specify Scanivalve #:

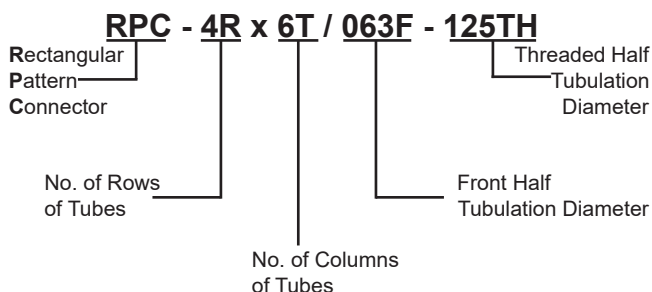

Scanivalve

Pneumatic Manifolds (500PSI)

The pneumatic manifolds are available in two designs, single manifold and double manifold. Tubulation sizes are .040 inch, .063 inch and .125 inch O.D. Lengths of the manifold are customer specified based on number of tubes. The maximum number is 12 tubes for a single manifold and 24 tubes for a double manifold.

Materials: Connector body is anodized aluminum. Tubulations are stainless steel.

Available Colors: CLR (clear), BLK (black), GLD (gold), RED, BLU (blue), and GRN (green). If a color is not specified at time of order, Scanivalve will supply a color based on availability.

M - Single Manifold (12 tube Maximum)



8 Tube Shown



12 Tube Shown

2M - Double Manifold (24 tube Maximum)

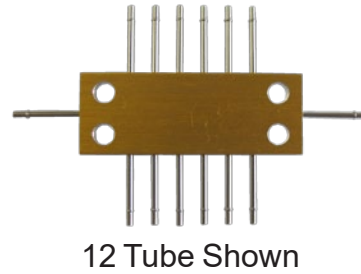

12 Tube Shown

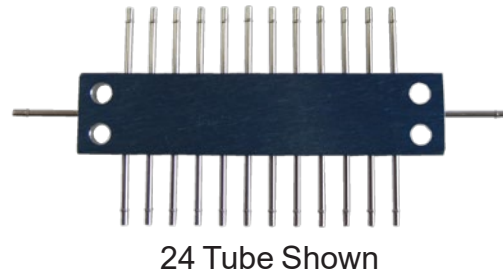

24 Tube Shown

| To order*, specify Scanivalve #: | |
|----------------------------------|-----------------------|
| Single Manifolds | Double Manifolds |
| TC 040 - M 3 (Color) | TC 040 - 2M 4 (Color) |
| TC 063 - M 3 (Color) | TC 063 - 2M 4 (Color) |
| TC 125 - M 3 (Color) | TC 125 - 2M 4 (Color) |

Tube Connector Specify Color
 Tubulation Size No. of Tubes
 Single Manifold

Tube Connector Specify Color
 Tubulation Size No. of Tubes
 Double Manifold

* Unique configurations may be available. Please visit Scanivalve.com and navigate to the manifolds webpage to find ordering forms for manifolds.





Tube Connectors

These connectors are made by affixing stainless steel tubulations into colored anodized aluminum blocks. The tube connectors are optionally available with a brass body with stainless steel tubulations soldered to the connector body for enhanced durability in harsh environments. All tubulations are bulged (except .031 and .250) for use with Scanivalve Helical Tubing Clamps.

Available Colors: CLR (clear), GLD (gold), BLK (black), RED, GRN (green), and BLU (blue). If a color is not specified at the time of order, Scanivalve will supply a color based upon availability.

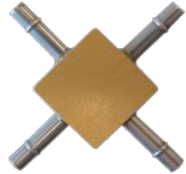
Sizes Available:

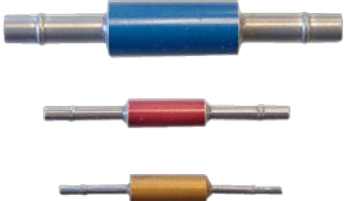
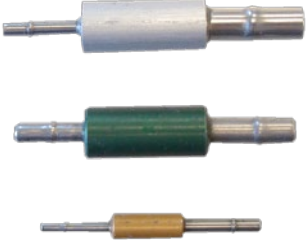
.031 (no bulge), .040, .063, .125, .250 (no bulge) inches O.D. All tubulation size combinations are available.

| To order, specify: | | | |
|---|--|-------|---|
| Item: | Scanivalve #: | Type: | Design: |
| Tube Connector "X" Design | TC 040 X (specify color) TC 063 X TC 125 X | "X" |  |
| Tube Connector "T" Design | TC 040 T (specify color) TC 063 T TC 125 T | "T" |  |
| Tube Connector "I" Design (In-Line) | TC 040 I (specify color) TC 063 I TC 125 I | "I" |  |
| Tube Connector "R" Design* (Reducer) | TC 040-031 R (specify color) TC 063-031 R TC 063-040 R TC 125-031 R TC 125-040 R TC 125-063 R TC 187-125 R TC 250-063 R | "R" |  |
| Tube Connector "P" Design (Plug) | TC 040 P (specify color) TC 063 P TC 125 P | "P" |  |

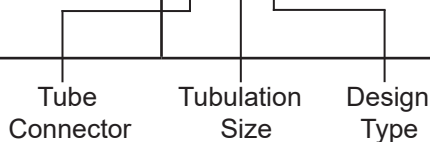

*Two sizes required for "R" Connector

Quick Couplers

Quick Coupler (Patented)

This quick coupler is designed for use during pressure testing where there is a need for changing pressure inputs quickly. They can be used with various lengths of stainless steel tubing with chamfered ends. The QC063-2 quick coupler is capable of operating at pressures up to 1000 psi.

Use:

1. To connect, push smooth end of tubing into coupler. Tubing is sealed with a captured internal O-ring and mechanically held by the collet which is initially closed by spring force. When the coupler is pressureized, an internal piston applies additional closing force to the collet.
2. To disconnect, shut off the air supply and then depress the collet.

Quick Coupler Designs

QC-XXX-2

The model -2 quick coupler design incorporates 2 collets in order to accept a steel tubulation at each end.

QC-XXX-TH

The model -TH quick coupler design incorporates a collet at one end and a threaded nose and O-Ring at the other end. The .063 version comes with an 8-32 thread, and the .125 version has a 1/4-28 thread.

QC-XXX-TUBN-XXX

The model -TUBN quick coupler design incorporates a collet at one end and a .063 or .125 inch tubulation on one end.

TUBN-XXX-X

See Stainless Steel Tubulations on page 3.

CAUTION:

Do not push bulged end of tubulation into coupler. A chamfered edge is required.



QC063-2



QC063-TH8



QC063-TUBN063

Ordering Information

| To order, specify Scanivalve #: | | .063 O.D. Tubulation Size | .125 O.D. Tubulation Size |
|---------------------------------|------------|---------------------------|---------------------------|
| Collet Each End | Model-2 | QC063-2 | QC125-2 |
| Thread One End | Model-TH | QC063-TH8 | QC125-TH25 |
| Tube One End | Model-TUBN | QC063-TUBN063 | QC125-TUBN125 |

Purge Adaptors

Different purge adaptors for multiple different connectors are available. These purge adaptors allow you to apply a single pneumatic “purge” pressure through a multi-channel pneumatic connector, such as the 73ZOC, 70MPS, or 32MPS connectors.

These adaptors are popular for users that wish to purge input lines connected to pressure modules using pressures that are higher than the max purge pressure rating of modules (max pressure varies by pressure range). The adaptors are used to bypass the pressure scanner and perform high pressure purges through the pressure scanners mating connector and input lines. Purge pressure is then limited to the plastic tubing used and the plastic tubing connections.



MPS Purge Adaptor

The MPS purge adaptor is a simple accessory that allows for a user to purge pneumatic lines that are connected to the 32MPSM connector, or the Px Input Header on a MPS4264 or MPS4232. Simply connect the 32MPSM or Px Header from an MPS4264 or MPS4232 to the purge adaptor, and supply a purge pressure to clear contaminants, dust, debris, and moisture from the connected lines.

To Order, Specify: 20369-01

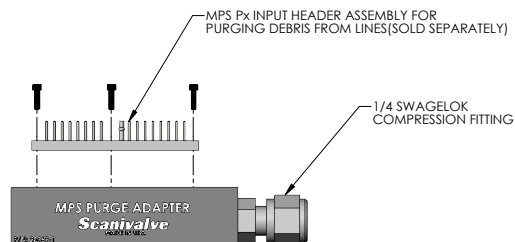
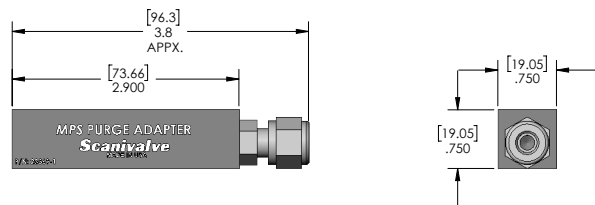

TCU Purge Adaptor

The TCU purge adaptor is a simple accessory that allows for a user to purge pneumatic lines that are connected to the 73ZOCCM or 70MPSM connector (most commonly used with the ZOCTCU and MPSTUC). For 73ZOC connectors, the purge adaptor can be configured for either a ZOC33TCU or ZOC22TCU (see part numbers below). Simply connect the circular connector to the purge adaptor, and supply a purge pressure to clear contaminants, dust, debris, and moisture from the connected lines.

To Order, Specify:

For 73ZOCCM, ZOC33TCU, or 70MPSM purge adaptor: 6563-01

For 32 channel ZOC22TCU: 6563-02

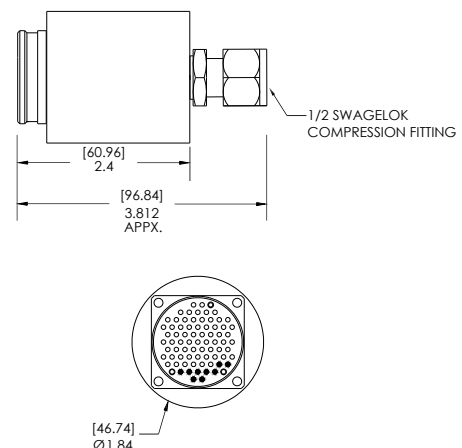

All measurements = Inches [mm]

Scanivalve

Pneumatic Calibration/Purge Valve

The pneumatic calibration/ purge valve is a 3 way, 8 channel (8P-3T) pneumatic logic valve ideal for installation into pressure sensor systems where purging or calibrations may be required. This valve assembly allows eight (8) inputs from a test article to be switched for purging, isolation from the inputs, or for "calibration" mode. The valve can configure eight (8) individual pressure sensors on the output side for these different modes. A 90-120 psi control pressure is required to switch the valve from the default measurement mode to the calibration, purge, or isolate mode.

All installed bulged tubulations are 0.063" OD (inputs, outputs, and controls). Mounting holes are provided on the REF manifold (), and are tapped 6-32 thds x .200 deep.

Ordering Information: ZOCCAL/ADPT

When no control pressure is applied, the valve will be in "operate" or measurement mode, where each input is isolated to the related output (input 1 to output 1, etc).

In isolate mode, all inputs are blocked off as to not allow the pressure at the inputs to flow through the valve and to the outputs.

In calibration mode, input pressures are isolated, and all 8 outputs are manifolded internally, allowing the user to apply a single pressure to the 8 outputs.

In purge mode, all inputs are isolated, the 8 outputs are manifolded together, and a purging pressure can be applied in order to allow purge air to flow out of the inputs to help remove dust, debris, moisture, or contamination away from the sensitive pressure sensors connected to the outputs.

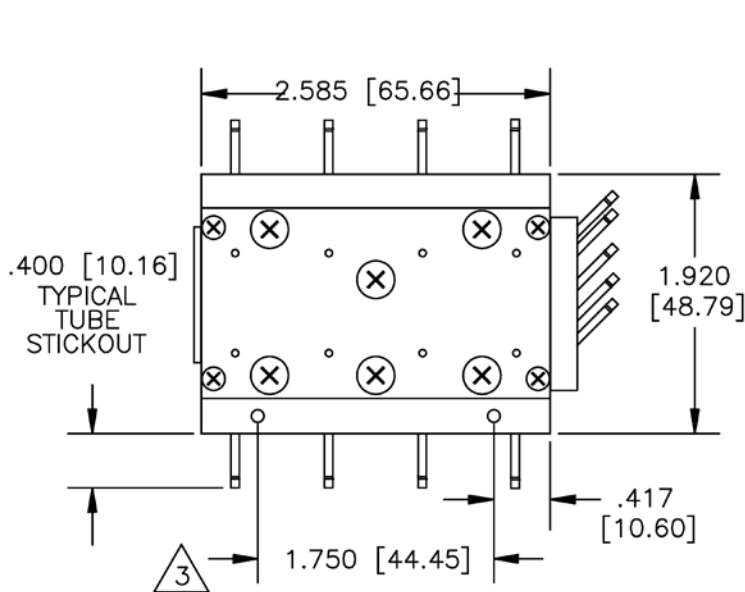
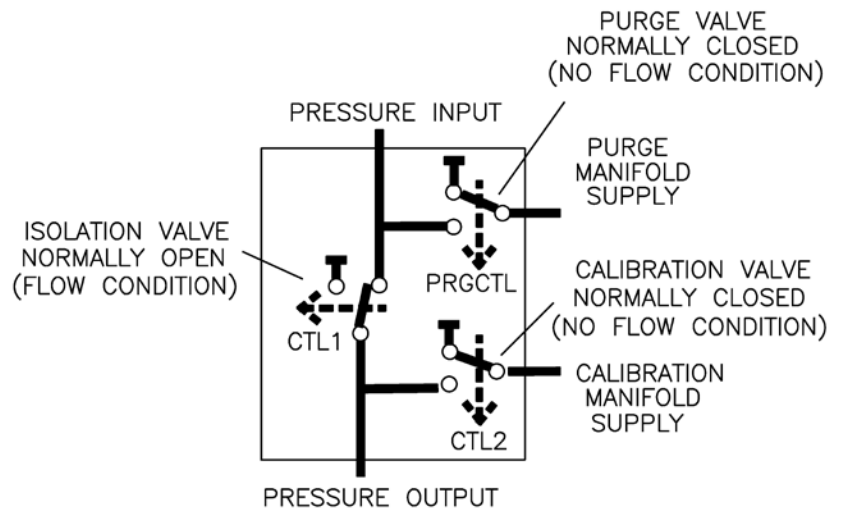

All measurements = Inches [mm]

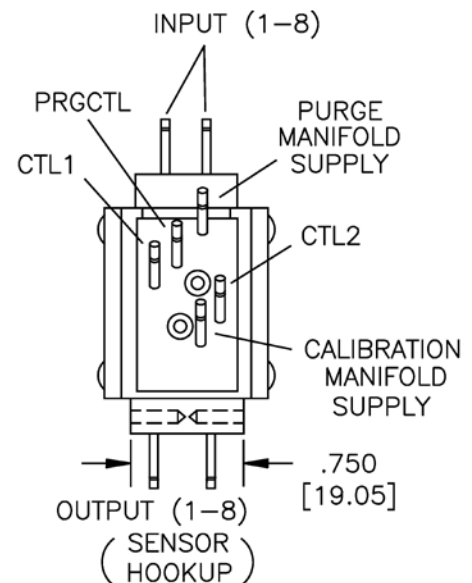

Scanivalve's Industry Leading Pressure and Temperature Measurement Instrumentation



**Miniature Intelligent
Pressure Measurement**



**Intelligent Gas and Liquid
Pressure Measurement**



**Ethernet Controllable
System Orchestration Module**

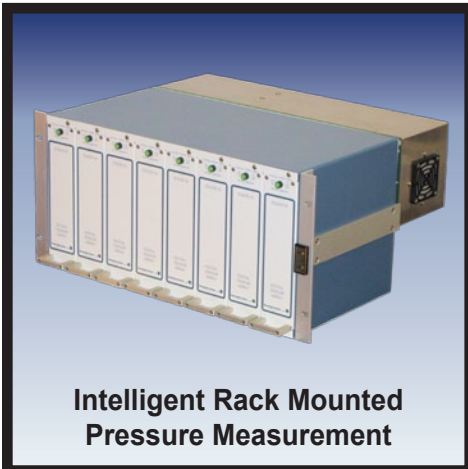

**Intelligent Rack Mounted
Pressure Measurement**



**Application Specific
Custom Measurement Systems**



**Miniature Analog
Pressure Scanners**



**Ethernet Based Data
Acquisition Systems**



**Multi-Range Servo
Pressure Calibrator**



**Intelligent 16, 32, and 64 Chan.
Thermocouple Scanner**

EvoMestec Postfach 10 02 35 61169 Friedberg Deutschland|
T +49 162 3340134
E info@evomestec.de
W www.EvoMestec.de

